

U 4.165

Ersatzteilliste
 Spare parts list
 Liste de pièces de rechange
 Listino pezzi di ricambio
 Lista de piezas de recambio
 Reserveonderdelenlijst
 Reservdelistsite
 Reservdelistsita

Reservdelistsite
 Varaosaluettelo
 Wykaz części zamiennych
 Seznam náhradních dílů
 Tartalékalkatrész lista
 Κατάλογος ανταλλακτικών
 Yedek parça listesi
 Перечень запасных частей
 备用零件目录
 スペアパーツリスト

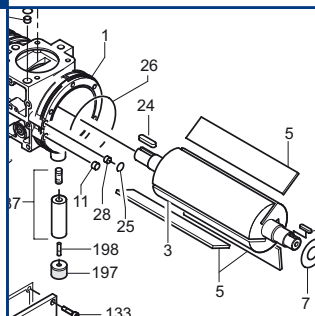

SERVICE

BECKER
D-42279 Wuppertal
www.becker-international.com

year

No **F**

type **U 4.165-XX**

frequency Hz

speed min⁻¹

power required kW

inlet capacity m³/h

pressure + mbar

vacuum - mbar

Made in Germany

Index Variante

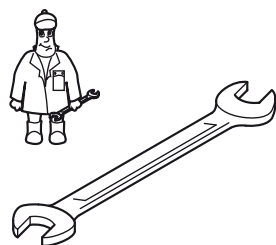
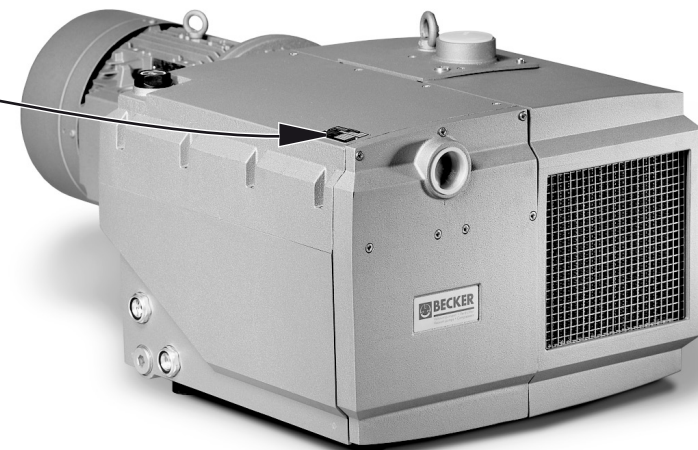

Pos.	Menge ²⁾ Quantity Quantité Quantità Cantidad	Bestell-Nr. Ident No. No. Identification No. Identificazione No. de pedido	Bezeichnung Description Designation Designazione Descripción
□	1	549000 26400	Dichtungssatz, Complete set of seals, Jeu de joints, Kit di guarnizioni, Junta Completa
5	SATZ/KIT	900505 00003	Schieber, Rotor Vane, Palette, Empujador
83	2	965415 00000	Luftentölelement, Oil separating element, Element separation huile, Cartuccia sepa-ratore olio, Elemento de desaceitar de aire

²⁾ erforderliche Bestellmenge / necessary order quantity / quantité nécessaire / quantità di ordinazione necessari / cantidad necesario

Wartung
Maintenance
Entretien
Manutenzione
Mantenimiento



SERVICE

www.becker-international.com

Sales and service network

U 4.165

Standard



Variante



U 4.165/XX

- ① U 4.165 F/K
- ②③ U 4.165 SA/K-25 + F/K-25
- ④⑤ U 4.165 SA/K-25.1 + F/K-25.1
- ⑥ U 4.165 SA/K-51 + F/K-51
- ⑦ U 4.165 SA/K-54

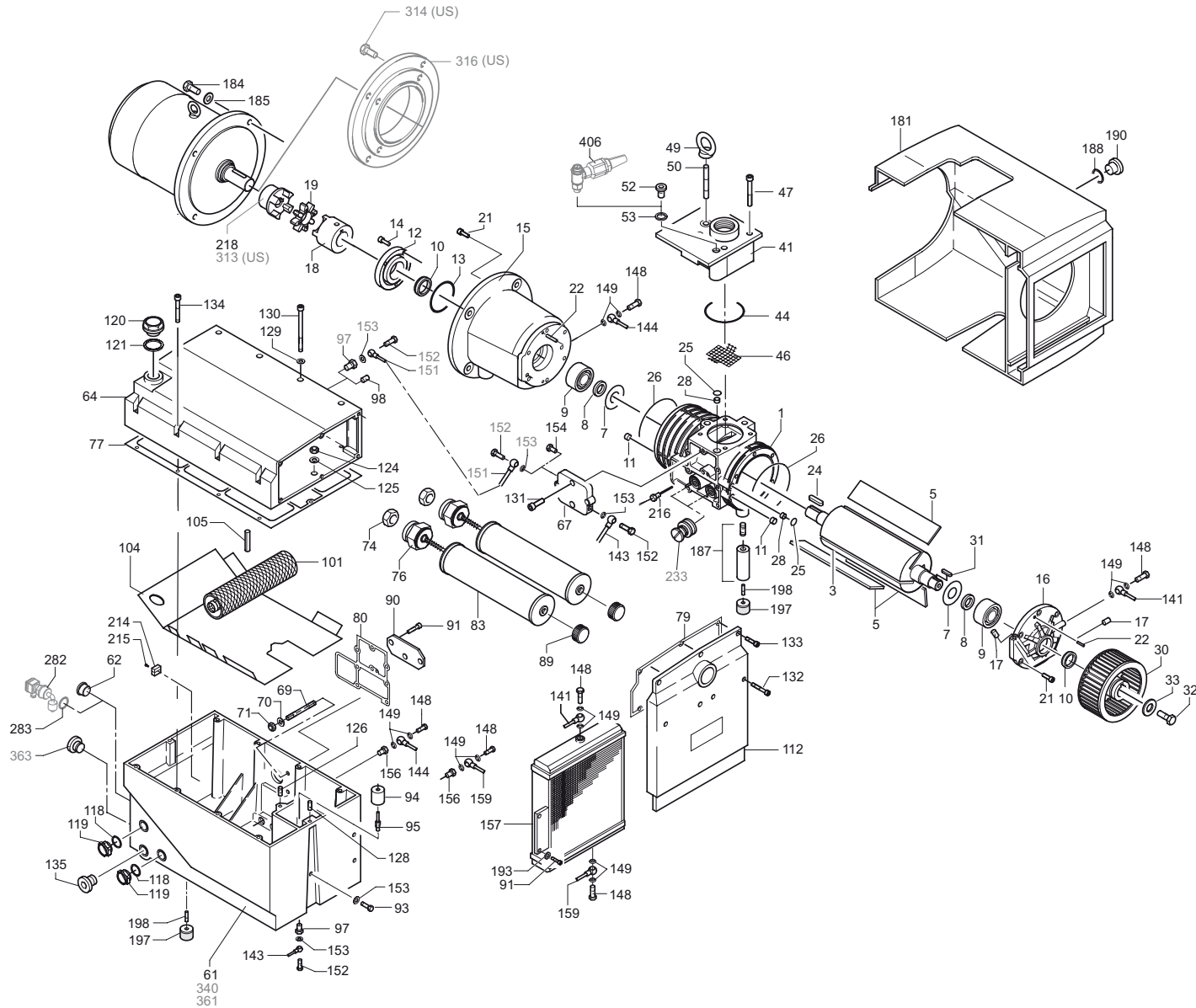

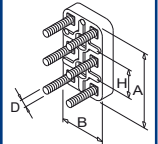
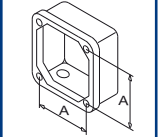
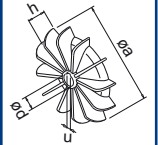
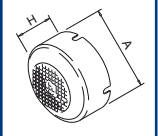
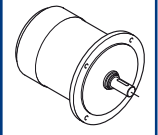

SERVICE ?



F INDEX	Pos.	Bestell Nr.	Beschreibung	DE	
				FR	
U 4.165	□	549000 26400	DICHTUNGSSATZ ¹⁾		
	1	000101 26300	GEHÄUSE		
	3	020000 26300	KOLBEN		
	5	900505 00003	SCHIEBER, KUNSTSTOFF (SATZ) ²⁾		
	7	917611 00000	LAGERDICHTRING		
	8	911472 00000	DISTANZSCHEIBE		
	9	906662 00000	WÄLZLAGER 6207 DIN 625		
	10	906576 00000	WELLENDICHTRING		
	11	912821 00000	VERSCHLUSS-DECKEL		
	12	001101 26400	LAGERDECKEL		
	14	945319 00000	INNENSECHSKANTSCHRAUBE		
	15	000800 26400	SEITENDECKEL MIT LATERNE		
	16	000702 26400	SEITENDECKEL		
17	912871 00000	VERSCHLUSS-SCHRAUBE			
18	902108 00000	GEBLÄSEKUPPLUNG, Ø28MM			
19	902210 00000	KUPPLUNGSSCHEIBE			
21	945331 00000	INNENSECHSKANTSCHRAUBE			
22	948742 00000	PASSKERBSTIFT			
24	947733 00000	PASSFEDER			
28	952008 00000	SPANNHÜLSE			
30	502301 26400	VENTILATOR MIT NABE			
31	947732 00000	PASSFEDER			
32	945270 00000	WELLENENDSCHRAUBE			
33	949409 00000	UNTERLEGSCHNEIBE			
41	537502 26400	RÜCKSCHLAGVENTIL, KOMPL.			
46	008002 26400	SIEB			
47	945371 00000	INNENSECHSKANTSCHRAUBE			
49	951602 00000	RINGMUTTER			
50	946969 00000	STIFTSCHRAUBE			
52	951228 00000	VERSCHLUSS-SCHRAUBE			
61	002406 26400	ABSCHIEDERGEHÄUSE			
62	951221 00100	VERSCHLUSS-SCHRAUBE			
64	001702 26400	ÖLBEHÄLTER-DECKEL			
67	003704 26400	DECKEL			
69	946968 00000	STIFTSCHRAUBE			
70	917107 00000	TELLERFEDER			
71	947105 00000	SECHSKANTMUTTER			
74	305800 02000	ÜBERWURFMUTTER			
76	727505 99628	ABBLASEVENTIL			
83	965415 00000	LUFTENTÖLELEMENT (2x) ²⁾			
89	921500 50000	HANDGRIFF			
90	013300 26400	PRALLBLECH			
91	945318 00000	INNENSECHSKANTSCHRAUBE			
93	945226 00000	SECHSKANTSCHRAUBE			
94	867800 99559	SCHWIMMER			
95	003300 10700	DÜSE			
98	912871 00000	VERSCHLUSS-SCHRAUBE			
101	506000 26400	GROBABSCHIEDER, KOMPLETT			
104	008003 26400	SIEB			
105	952014 00000	SPANNHÜLSE			
112	003703 26400	DECKEL			
119	907309 00000	ÖLSCHAUGLAS			
120	916800 10000	SCHRAUBDECKEL			
124	947104 00000	SECHSKANTMUTTER			
125	948504 00000	FEDERRING			
126	951001 02000	STIFTSCHRAUBE			
128	951003 02000	STIFTSCHRAUBE			
130	945383 00000	INNENSECHSKANTSCHRAUBE			
131	945230 00000	SECHSKANTSCHRAUBE			

F INDEX	Pos.	Bestell Nr.	Beschreibung	DE	
				FR	
	132	945363 00000	INNENSECHSKANTSCHRAUBE		
	133	945321 00000	INNENSECHSKANTSCHRAUBE		
	134	945324 00000	INNENSECHSKANTSCHRAUBE		
	135	951220 00100	VERSCHLUSS-SCHRAUBE		
	141	012215 26400	LEITUNG		
	143	012202 26400	ÖLRÜCKFÜHRLEITUNG		
	144	012216 26400	LEITUNG		
	148	948402 00000	HOHLSCHRAUBE		
	152	009400 19000	KUGELSTÜCKSCHRAUBE		
	154	012900 19000	VERSCHLUSS-SCHRAUBE		
	156	912306 00000	ANSCHLUSS-SCHRAUBE		
	157	960201 26400	KÜHLER		
	159	012214 26400	LEITUNG		
	181	018301 26400	HAUBE		
	184	945237 00000	SECHSKANTSCHRAUBE		
	185	947506 00000	UNTERLEGSCHNEIBE		
	187	568100 26400	STÜTZE		
	188	949408 00000	U-SCHNEIBE		
	190	945227 00000	WELLENABSCHLUSS-SCHRAUBE		
	193	949203 00000	ZAHNSCHNEIBE		
	197	741302 00000	GUMMIPUFFER		
	198	945634 00000	GEWINDESTIFT		
	214	950700 10000	LÜSTERKLEMMME		
	215	946304 00000	INNENSECHSKANTSCHRAUBE		
	216	943400 90000	TEMPERATURFÜHLER		
	218	902108 00000	MOTORKUPPLUNG, Ø28MM		
	282	741103 99682	NIVEAUGEBER - OPTIONAL		
	313	902100 26300	MOTORKUPPLUNG (US)		
	314	945236 00000	SECHSKANTSCHRAUBE (US)		
	316	037900 12900	ZWISCHENFLANSCH (US)		
	406	768705 99626	GASBALLASTVENTIL - OPTIONAL		
		960009 00200	BECKER LUBE M 100 (MINERALÖL) - 5L		
		960016 00200	BECKER LUBE S 100 (SYNTHETIKÖL) - 5L		
		960023 00200	BECKER LUBE SL 100 (LEBENSMITTELBEREICH) - 5L		
¹⁾ Dichtungssatz - 549000 26400 - Pos.: 13, 25, 26, 44, 53, 63, 77, 79, 80, 118, 121, 129, 136, 149, 153, 283 ²⁾ erforderliche Bestellmenge / Wartung					

F INDEX	Pos.	Ident No.	Description	
U 4.165	□	549000 26400	SET OF SEALS ¹⁾	
	1	000101 26300	PUMP BODY	
	3	020000 26300	ROTOR	
	5	900505 00003	ROTOR VANE IN PLASTIC (KIT) ²⁾	
	7	917611 00000	BEARING SEALING WASHER	
	8	911472 00000	DISTANCE DISC	
	9	906662 00000	BEARING 6207 DIN 625	
	10	906576 00000	SHAFT SEALING RING	
	11	912821 00000	CAP	
	12	001101 26400	BEARING COVER	
	14	945319 00000	SOCKET HEAD SCREW	
	15	000800 26400	LID WITH FLANGE	
	16	000702 26400	LID	
17	912871 00000	LOCKING SCREW		
18	902108 00000	COUPLING PUMP, Ø28MM		
19	902210 00000	COUPLING DISC		
21	945331 00000	SOCKET HEAD SCREW		
22	948742 00000	STRAIGHT PIN		
24	947733 00000	KEY		
28	952008 00000	LOCATING PEG		
30	502301 26400	FAN		
31	947732 00000	KEY		
32	945270 00000	SHAFT END BOLD		
33	949409 00000	WASHER		
41	537502 26400	NON RETURN VALVE, ENTIRE		
46	008002 26400	SIEVE		
47	945371 00000	SOCKET HEAD SCREW		
49	951602 00000	RING UNIT		
50	946969 00000	STUD		
52	951228 00000	LOCKING SCREW		
61	002406 26400	HOUSING FOR OIL SEPARATION		
62	951221 00100	LOCKING SCREW		
64	001702 26400	OIL TANK COVER		
67	003704 26400	COVER		
69	946968 00000	STUD		
70	917107 00000	SPRING COLLAR		
71	947105 00000	HEX.NUT		
74	305800 02000	COUPLING NUT		
76	727505 99628	BLOW OFF VALVE		
83	965415 00000	OIL SEPARATION ELEMENT (2x) ²⁾		
89	921500 50000	HANDLE		
90	013300 26400	METAL FILTER		
91	945318 00000	SOCKET HEAD SCREW		
93	945226 00000	HEX. HEAD SCREW		
94	867800 99559	FLOAT		
95	003300 10700	NOZZLE		
98	912871 00000	LOCKING SCREW		
101	506000 26400	COARSE SEPARATOR		
104	008003 26400	SIEVE		
105	952014 00000	FIXING SLEEVE		
112	003703 26400	COVER		
119	907309 00000	OIL SIGHT GLASS		
120	916800 10000	COVER		
124	947104 00000	HEX.NUT		
125	948504 00000	SPRING WASHER		
126	951001 02000	STUD		
128	951003 02000	STUD		
130	945383 00000	SOCKET HEAD SCREW		
131	945230 00000	HEX-HEAD SCREW		

F INDEX	Pos.	Ident No.	Description	
	132	945363 00000	SOCKET HEAD SCREW	
	133	945321 00000	SOCKET HEAD SCREW	
	134	945324 00000	SOCKET HEAD SCREW	
	135	951220 00100	LOCKING SCREW	
	141	012215 26400	PIPE	
	143	012202 26400	OIL RETURN PIPE	
	144	012216 26400	PIPE	
	148	948402 00000	HOLLOW SCREW	
	152	009400 19000	HOLLOW HOLDING SCREW	
	154	012900 19000	LOCKING SCREW	
	156	912306 00000	CONNECTING SCREW	
	157	960201 26400	COOLER	
	159	012214 26400	PIPE	
	181	018301 26400	PROTECTING HOOD	
	184	945237 00000	HEX-HEAD SCREW	
	185	947506 00000	WASHER	
	187	568100 26400	SUPPORT PILLAR	
	188	949408 00000	WASHER	
	190	945227 00000	SCREW	
	193	949203 00000	TOOTHED SPRING WASHER	
	197	741302 00000	RUBBER BUFFER	
	198	945634 00000	THREADED PIN	
	214	950700 10000	LUSTER TERMINAL	
	215	946304 00000	SOCKET HEAD SCREW	
	216	943400 90000	TEMPERATURE PROBE	
	218	902108 00000	COUPLING MOTOR SIDE Ø28MM	
	282	741103 99682	OIL LEVEL CONTROL - OPTIONAL	
	313	902100 26300	COUPLING MOTOR SIDE (US)	
	314	945236 00000	HEX-HEAD SCREW (US)	
	316	037900 12900	FLANGES (US)	
	406	768705 99626	GAS BALLAST VALVE - OPTIONAL	
		960009 00200	BECKER LUBE M 100 (MINERAL OIL) - 5L	
		960016 00200	BECKER LUBE S 100 (SYNTHETIC OIL) - 5L	
		960023 00200	BECKER LUBE SL 100 (FOOD SECTOR) - 5L	
¹⁾ Set of seals - 549000 26400 - Pos.: 13, 25, 26, 44, 53, 63, 77, 79, 80, 118, 121, 129, 136, 149, 153, 283 ²⁾ necessary order quantity / maintenance				

F INDICE	Pos.	No. Identification	Designation	FR	
				U 4.165	
	■	549000 26400	JEU DE JOINTS ¹⁾		
	1	000101 26300	CORP DE POMPE		
	3	020000 26300	PISTON		
	5	900505 00003	PALETTE ON PLASTIQUE (KIT) ²⁾		
	7	917611 00000	RONDELLE D'ETANCHEITE DU ROULEMENT		
	8	911472 00000	DISQUE AJUSTAGE		
	9	906662 00000	ROULEMENT 6207 DIN 625		
	10	906576 00000	BAGUE D'ETANCHEITE P.L'AXE		
	11	912821 00000	COUVERCLE		
	12	001101 26400	COUVERCLE DE ROULEMENTE		
	14	945319 00000	VIS HEXAGONALE INTERNE		
	15	000800 26400	COUVERCLE AVEC BRIDE		
	16	000702 26400	COUVERCLE		
	17	912871 00000	BOUCHON		
	18	902108 00000	ACCOUPLLEMENT POMPE, Ø28MM		
	19	902210 00000	DISQUE D'ACCOUPLLEMENT		
	21	945331 00000	VIS HEXAGONALE INTERNE		
	22	948742 00000	GOUPILLE CYLINDRIQUE		
	24	947733 00000	CLAVETTE		
	28	952008 00000	DOVILLE DE ETRAGE		
	30	502301 26400	VENTILATEUR		
	31	947732 00000	CLAVETTE		
	32	945270 00000	VIS BOUT D'ARBRE		
	33	949409 00000	RONDELLE		
	41	537502 26400	SOUPAPE ANTI-RETOUR, ENTIER		
	46	008002 26400	FILTRE		
	47	945371 00000	VIS HEXAGONALE INTERNE		
	49	951602 00000	ECROU A ANNEAU		
	50	946969 00000	PRISONNIER		
	52	951228 00000	BOUCHON		
	61	002406 26400	CORP DE SEPARATEUR D'HUILE		
	62	951221 00100	BOUCHON		
	64	001702 26400	COUVERCLE RESERVOIR D'HUILE		
	67	003704 26400	COUVERCLE		
	69	946968 00000	PRISONNIER		
	70	917107 00000	RONDELLE À RESSORT		
	71	947105 00000	ECROU A 6 PANS		
	74	305800 02000	ECROU		
	76	727505 99628	SILENCIEUX		
	83	965415 00000	ELEMENT SEPARATION HUILE (2x) ²⁾		
	89	921500 50000	POIGNEE		
	90	013300 26400	FILTRE METALIQUE		
	91	945318 00000	VIS HEXAGONALE INTERNE		
	93	945226 00000	VIS HEXAGONALE		
	94	867800 99559	PIED CAOUTCHOVE		
	95	003300 10700	GICLEUR		
	98	912871 00000	BOUCHON		
	101	506000 26400	SEPARATEUR A GROS		
	104	008003 26400	FILTRE		
	105	952014 00000	MANCHON DE FIXATION		
	112	003703 26400	COUVERCLE		
	119	907309 00000	VERRE REGARD		
	120	916800 10000	COUVERCLE		
	124	947104 00000	ECROU A 6PANS		
	125	948504 00000	ANNEAU-RESSORT		
	126	951001 02000	PRISONNIER		
	128	951003 02000	PRISONNIER		
	130	945383 00000	VIS HEXAGONALE INTERNE		
	131	945230 00000	VIS HEXAGONALE		

F INDICE	Pos.	No. Identification	Designation	FR	
	132	945363 00000	VIS HEXAGONALE INTERNE		
	133	945321 00000	VIS HEXAGONALE INTERNE		
	134	945324 00000	VIS HEXAGONALE INTERNE		
	135	951220 00100	BOUCHON		
	141	012215 26400	TUYAU		
	143	012202 26400	TUYAU D'HUILE		
	144	012216 26400	TUYAU		
	148	948402 00000	VIS CREUSE		
	152	009400 19000	VIS CREUSE DE FIXATION		
	154	012900 19000	BUCHON		
	156	912306 00000	VIS DE RACCORD		
	157	960201 26400	REFROIDISSEUR		
	159	012214 26400	TUYAU		
	181	018301 26400	CARTER PROTECTEUR		
	184	945237 00000	VIS HEXAGONALE		
	185	947506 00000	RONDELLE		
	187	568100 26400	SUPPORT INTERMEDIAIRE		
	188	949408 00000	RONDELLE		
	190	945227 00000	VIS		
	193	949203 00000	DENT DISQUE		
	197	741302 00000	AMORTISSEUR EN CAOUTCHOUC		
	198	945634 00000	GOUPILLE FILETEE		
	214	950700 10000	SERRE-FILS		
	215	946304 00000	VIS HEXAGONALE INTERNE		
	216	943400 90000	PALPEUR DE TEMPERATURE		
	218	902108 00000	ACCOUPLLEMENT MOTEUR Ø28MM		
	282	741103 99682	INDICATEUR DE NIVEAU - EN OPTION		
	313	902100 26300	ACCOUPLLEMENT MOTEUR (US)		
	314	945236 00000	VIS HEXAGONALE (US)		
	316	037900 12900	BRIDES (US)		
	406	768705 99626	L'ESTE D'AIR - EN OPTION		
		960009 00200	BECKER LUBE M 100 (HUILE MINÉRALE) - 5L		
		960016 00200	BECKER LUBE S 100 (L'HUILE SYNTHÉTIQUE) - 5L		
		960023 00200	BECKER LUBE SL 100 (SECTEUR DE L'ALIMENTATION) - 5L		
¹⁾ Jeu de joints - 549000 26400 - Pos.: 13, 25, 26, 44, 53, 63, 77, 79, 80, 118, 121, 129, 136, 149, 153, 283 ²⁾ quantité nécessaire / entretien					

F INDICE	Pos.	No. Identificazione	Designazione	IT	
U 4.165	□	549000 26400	SERIE DI GUARNIZIONE ¹⁾		
	1	000101 26300	CARCASSA		
	3	020000 26300	ROTORE		
	5	900505 00003	PALETTE IN PLASTICA (KIT) ²⁾		
	7	917611 00000	ANELLO DI TENUTA DEL CUSCINETTO		
	8	911472 00000	DISCO DISTANZA		
	9	906662 00000	CUSCINETTO 6207 DIN 625		
	10	906576 00000	GUARNIZIONE PER L'ALBERO		
	11	912821 00000	COPERCHIO		
	12	001101 26400	COPERCHIO CUSCINETTO		
	14	945319 00000	VITE ESAGONALE INTERNA		
	15	000800 26400	COPERCHIO CON FLANGIA		
	16	000702 26400	COPERCHIO		
17	912871 00000	VITE DI CHIUSURA			
18	902108 00000	GIUNTO POMPA, Ø28MM			
19	902210 00000	DISCO GUINTO			
21	945331 00000	VITE ESAGONALE INTERNA			
22	948742 00000	PERNO			
24	947733 00000	CHIAVETTA			
28	952008 00000	SPINE DI RISCONTRO			
30	502301 26400	VENTILATORE			
31	947732 00000	CHIAVETTA			
32	945270 00000	VITE DI CHIUSURA ALBERO			
33	949409 00000	RONDELLA			
41	537502 26400	VALVOLA NON RITORNO, INTERO			
46	008002 26400	FILTRO			
47	945371 00000	VITE ESAGONALE INTERNA			
49	951602 00000	GOLFARE CON FORO FILETTATO			
50	946969 00000	L'ASTA A VITE			
52	951228 00000	VITE DI CHIUSURA			
61	002406 26400	CARCASSA SEPARATORE OLIO			
62	951221 00100	VITE DI CHIUSURA			
64	001702 26400	COPERCHIO SERBATOIO OLIO			
67	003704 26400	COPERCHIO			
69	946968 00000	L'ASTA A VITE			
70	917107 00000	RONDELLA A MOLLA			
71	947105 00000	DADO ESAGONALE			
74	305800 02000	DADO DI RISVOLTO			
76	727505 99628	SILENZIATORE			
83	965415 00000	CARTUCCIA SEPARATORE OLIO (2x) ²⁾			
89	921500 50000	MANETTA			
90	013300 26400	FILTRO METALICO			
91	945318 00000	VITE ESAGONALE INTERNA			
93	945226 00000	VITE ESAGONALE			
94	867800 99559	GALLEGGIANTE			
95	003300 10700	UGELLO			
98	912871 00000	VITE DI CHIUSURA			
101	506000 26400	SEPARATORE GROSSOLANO			
104	008003 26400	FILTRO			
105	952014 00000	MANICOTTO DI FISSAZIONE			
112	003703 26400	COPERCHIO			
119	907309 00000	SPIA LIVELLO OLIO			
120	916800 10000	COPERCHIO			
124	947104 00000	DADO ESAGONALE			
125	948504 00000	ANELLO A MOLLA			
126	951001 02000	L'ASTA A VITE			
128	951003 02000	L'ASTA A VITE			
130	945383 00000	VITE ESAGONALE INTERNA			
131	945230 00000	VITE ESAGONALE			







F INDICE	Pos.	No. Identificazione	Designazione	IT	
	132	945363 00000	VITE ESAGONALE INTERNA		
	133	945321 00000	VITE ESAGONALE INTERNA		
	134	945324 00000	VITE ESAGONALE INTERNA		
	135	951220 00100	VITE DI CHIUSURA		
	141	012215 26400	CONDOTTO		
	143	012202 26400	CONDOTTO OLIO		
	144	012216 26400	CONDOTTO		
	148	948402 00000	VITE ESAGONALE		
	152	009400 19000	VITE PASSAGGIO OLIO		
	154	012900 19000	VITE DI CHIUSURA		
	156	912306 00000	ATTACO FILETTATO		
	157	960201 26400	RAFFREDDATORE		
	159	012214 26400	CONDOTTO		
	181	018301 26400	CARTER DI PROTEZIONE		
	184	945237 00000	VITE ESAGONALE		
	185	947506 00000	RONDELLA		
	187	568100 26400	SUPPORTO		
	188	949408 00000	RONDELLA		
	190	945227 00000	VITE		
	193	949203 00000	DISCO A DENTE		
	197	741302 00000	AMMORTIZZATORE IN GOMMA		
	198	945634 00000	SPINA FILETTATURA		
	214	950700 10000	SCATOLA DEI CONNETTORI		
	215	946304 00000	VITE ESAGONALE INTERNA		
	216	943400 90000	TASTATORE TEMPERATURE		
	218	902108 00000	GIUNTO MOTORE Ø28MM		
	282	741103 99682	SONDA D'OLIO - OPTIONALE		
	313	902100 26300	GUINTO MOTORE (US)		
	314	945236 00000	VITE ESAGONALE (US)		
	316	037900 12900	FLANGE (US)		
	406	768705 99626	VALVOLA DI ZAVORATRICE - OPTIONALE		
		960009 00200	BECKER LUBE M 100 (OLIO MINERALE) - 5L		
		960016 00200	BECKER LUBE S 100 (OLIO SINTETICO) - 5L		
		960023 00200	BECKER LUBE SL 100 (SETTORE ALIMENTARE) - 5L		
¹⁾ Serie di guarnizione - 549000 26400 - Pos.: 13, 25, 26, 44, 53, 63, 77, 79, 80, 118, 121, 129, 136, 149, 153, 283 ²⁾ quantità di ordinazione necessari / manutenzione					

F INDICE	Pos.	No. De pedido	Descripción	ES	
				ES	
U 4.165	□	549000 26400	JUNTA COMPLETA ¹⁾		
	1	000101 26300	CARCASA		
	3	020000 26300	ÉMBOLO		
	5	900505 00003	EMPUJADOR DE PLÁSTICO (KIT) ²⁾		
	7	917611 00000	ANILLO DE COJINETE DE JUNTA		
	8	911472 00000	ARANDELA DISTANCIADORA		
	9	906662 00000	COJINETE DE RODAMIENTO 6207 DIN 625		
	10	906576 00000	ANILLO DE JUNTA DE ÁRBOL		
	11	912821 00000	TAPA DE CIERRE		
	12	001101 26400	TAPA LATERAL		
	14	945319 00000	TAPA LATERAL		
	15	000800 26400	TORNILLO DE CIERRE		
	16	000702 26400	MITAD DE ACOPLAMIENTO		
17	912871 00000	DISCO DE ACOPLAMIENTO			
18	902108 00000	TORNILLO HEXAGONAL INTERIOR			
19	902210 00000	PASADOR ENTALLADO DE AJUSTE			
21	945331 00000	LENGÜETA DE AJUSTE			
22	948742 00000	CASQUILLO TENSOR			
24	947733 00000	VENTILADOR CON CUBO			
28	952008 00000	LENGÜETA DE AJUSTE			
30	502301 26400	TORNILLO TERMINAL DE ÁRBOL			
31	947732 00000	ARANDELA			
32	945270 00000	FAROL			
33	949409 00000	TORNILLO HEXAGONAL INTERIOR			
41	537502 26400	VÁLVULA ANTIRRETORNO COMPLETA			
46	008002 26400	CRIBA			
47	945371 00000	TORNILLO HEXAGONAL INTERIOR			
49	951602 00000	TUERCA DE CÁNCAMO			
50	946969 00000	ESPÁRRAGO			
52	951228 00000	TORNILLO DE CIERRE			
61	002406 26400	CARCASA SEPARADORA			
62	951221 00100	TORNILLO DE CIERRE			
64	001702 26400	TAPA DE RECIPIENTE DE ACEITE			
67	003704 26400	TAPA			
69	946968 00000	ESPÁRRAGO			
70	917107 00000	ARANDELA DE APOYO DEL RESORTE			
71	947105 00000	TUERCA HEXAGONAL			
74	305800 02000	SOBRETUERCA			
76	727505 99628	VÁLVULA DE BARRIDO			
83	965415 00000	ELEMENTO DE DESACEITAR DE AIRE (2x) ²⁾			
89	921500 50000	EMPUÑADURA			
90	013300 26400	CHAPA DE REBOTE			
91	945318 00000	TORNILLO HEXAGONAL INTERIOR			
93	945226 00000	TORNILLO DE CABEZA HEXAGONAL			
94	867800 99559	FLOTADOR			
95	003300 10700	TOBERA			
98	912871 00000	TORNILLO DE CIERRE			
101	506000 26400	SEPARADOR DE SÓLIDOS GRUESOS COMPLETO			
104	008003 26400	CRIBA			
105	952014 00000	MANGUITO DE FIJACIÓN			
112	003703 26400	TAPA			
119	907309 00000	CRISTAL MIRILLA DE ACEITE			
120	916800 10000	TAPA ROSCADA			
124	947104 00000	TUERCA HEXAGONAL			
125	948504 00000	ARANDELA DE MUELLE			
126	951001 02000	ESPÁRRAGO			
128	951003 02000	ESPÁRRAGO			
130	945383 00000	TORNILLO HEXAGONAL INTERIOR			
131	945230 00000	TORNILLO HEXAGONAL			

F INDICE	Pos.	No. De pedido	Descripción	ES	
				ES	
	132	945363 00000	TORNILLO HEXAGONAL INTERIOR		
	133	945321 00000	TORNILLO HEXAGONAL INTERIOR		
	134	945324 00000	TORNILLO HEXAGONAL INTERIOR		
	135	951220 00100	TORNILLO DE CIERRE		
	141	012215 26400	CONDUCTO		
	143	012202 26400	CONDUCTO DE RETROALIMENTACIÓN DE ACEITE		
	144	012216 26400	CONDUCTO		
	148	948402 00000	TORNILLO HUECO		
	152	009400 19000	TORNILLO DE PIEZA ESFÉRICA		
	154	012900 19000	TORNILLO DE CIERRE		
	156	912306 00000	TORNILLO DE EMPALME		
	157	960201 26400	REFRIGERADOR		
	159	012214 26400	CONDUCTO		
	181	018301 26400	SOMBRERETE		
	184	945237 00000	TORNILLO DE CABEZA HEXAGONAL		
	185	947506 00000	ARANDELA		
	187	568100 26400	APOYO		
	188	949408 00000	ARANDELA		
	190	945227 00000	TORNILLO TERMINAL DE ÁRBOL		
	193	949203 00000	POLEA DENTADA		
	197	741302 00000	AMORTIGUADOR DE GOMA		
	198	945634 00000	VARILLA ROSCADA		
	214	950700 10000	CAJA DE CONEXIÓN		
	215	946304 00000	TORNILLO HEXAGONAL INTERIOR		
	216	943400 90000	SENSOR DE TEMPERATURA		
	218	902108 00000	ACOPLAMIENTO DE MOTOR Ø38MM		
	282	741103 99682	GENERADOR DE NIVEL - OPCIONAL		
	313	902100 26300	ACOPLAMIENTO DE MOTOR (US)		
	314	945236 00000	TORNILLO DE CABEZA HEXAGONAL (US)		
	316	037900 12900	BRIDA INTERMEDIA (US)		
	406	768705 99626	VÁLVULA DE LASTRE DE GAS - OPCIONAL		
		 960009 00200	BECKER LUBE M 100 (ACEITE MINERAL) - 5L		
		960016 00200	BECKER LUBE S 100 (ACEITE SINTÉTICO) - 5L		
		960023 00200	BECKER LUBE SL 100 (SECTOR ALIMENTARIO) - 5L		
¹⁾ Junta completa - 549000 26400 - Pos.: 13, 25, 26, 44, 53, 63, 77, 79, 80, 118, 121, 129, 136, 149, 153, 283 ²⁾ cantidad necesario / mantenimiento					

U 4.165	Variante 	Pos. ²⁾	Bestell Nr. / Ident No. / No. Identification / No. Identificazione / No. De pedido		Beschreibung / Description / Designation / Designazione / Descripcion	
① U 4.165 F/K		97	912300 00000		ANSCHLUSSSCHRAUBE / CONNECTING SCREW / VIS DE RACCORD / ATTACO FILETTATO / TORNILLO DE EMPALME	
		98		912871-00000	VERSCHLUSSSCHRAUBE / LOCKING SCREW / BOUCHON / VITE DI CHIUSURA / TORNILLO DE CIERRE	
		151	012203 26400		LEITUNG / OIL SUCTION PIPE / TUYAU D'HUILE / CONDOTTO OLIO / CONDUCTO DE ASPIRACIÓN DE ACEITE	
		152	009400 19000		KUGELSTÜCKSCHRAUBE / HOLLOW HOLDING SCREW / VIS CREUSE DE FIXATION / VITE PASSAGGIO OLIO / TORNILLO DE PIEZA ESFÉRICA	
		153	948002 00000		DICHTUNG / GASKET / JOINT / GUARNIZIONE / JUNTA	
		154		012900-19000	VERSCHLUSSSCHRAUBE / LOCKING SCREW / BOUCHON / VITE DI CHIUSURA / TORNILLO DE CIERRE	
		233	537503 26400		VENTIL, KOMPL. / VALVE, ENTIRE / SOUPAPE, ENTIER / VALVOLA, INTERO / VÁLVULA COMPLETA	
② U 4.165 SA/K-25 ③ U 4.165 F/K-25 - mit Öl-Wasser-Kühler - with oil-to-water heat exchanger - avec réfrigérant à l'huile et à l'eau - con radiatore ad olio - acqua - con refrigerador aceite-agua		91		945318-00000	INNENSECHSKANTSCHRAUBE / ALLEN SCREW / VIS ALLEN / VITE ESAGONALE INTERNA / TORNILLO HEXAGONAL INTERIOR	
		141	012210 26400		012215-26400	LEITUNG / PIPE / TUYAU / CONDOTTO / CONDUCTO
		142	012211 26400			LEITUNG / PIPE / TUYAU / CONDOTTO / CONDUCTO
		144			012216-26400	LEITUNG / PIPE / TUYAU / CONDOTTO / CONDUCTO
		145	012212 26400			LEITUNG / PIPE / TUYAU / CONDOTTO / CONDUCTO
		146	012202 26300			LEITUNG / PIPE / TUYAU / CONDOTTO / CONDUCTO
		156	912301 00000		912306-00000	ANSCHLUSSSCHRAUBE / CONNECTING SCREW / VIS DE RACCORD / ATTACO FILETTATO / TORNILLO DE EMPALME
		157			960201-26400	KUEHLER / COOLER / REFRROIDISSEUR / RAFFREDDATORE / REFRIGERADOR
		159			012214 26400	LEITUNG / PIPE / TUYAU / CONDOTTO / CONDUCTO
		181			018301-26400	HAUBE / PROTECTING HOOD / CARTER PROTECTEUR / CARTER DI PROTEZIONE / SOMBRERETE
		193			949203-00000	ZAHNSCHEIBE / TOOTHED LOCK WASHER / RONDELLE À DENTS / RONDELLA DENTATA / ARANDELA DENTADA
		203	960204 26200			KÜHLER / COOLER / REFRROIDISSEUR / RAFFREDDATORE / REFRIGERADOR
		204	969438 00000			L-VERSCHRÄUBUNG / L-PIECE / L-PIECE / PEZZO A L / ATORNILLADURA
		205	935200 10000			VERLÄNGERUNG / ADAPTOR / RACCORD INTERMÉDIAIRE / RACCORDO INTERMEDIO / ADAPTADOR
		206	969401 00009			SCHLAUCH / FLEXIBLE HOSE / TUYAUTERIE FLEXIBLE / TUBAZIONE FLESSIBILE / TUBERÍA FLEXIBLE
		208	018303 26400			HAUBE / PROTECTING HOOD / CARTER PROTECTEUR / CARTER DI PROTEZIONE / SOMBRERETE
209	922401 20000			SCHUTZGITTER / SAFETY GUARD / GRILLAGE DE PROTECTION / GABBIA DI PROTEZIONE / REJILLA DE PROTECCIÓN		
④ U 4.165 SA/K-25.1 ⑤ U 4.165 F/K-25.1 - mit Öl-Wasser-Kühler - with oil-to-water heat exchanger - avec réfrigérant à l'huile et à l'eau - con radiatore ad olio - acqua - con refrigerador aceite-agua		141	012217 26400		012215-26400	LEITUNG / PIPE / TUYAU / CONDOTTO / CONDUCTO
		142	012211 26400			LEITUNG / PIPE / TUYAU / CONDOTTO / CONDUCTO
		145	012212 26400			LEITUNG / PIPE / TUYAU / CONDOTTO / CONDUCTO
		146	012202 26300			LEITUNG / PIPE / TUYAU / CONDOTTO / CONDUCTO
		181			018301-26400	HAUBE / PROTECTING HOOD / CARTER PROTECTEUR / CARTER DI PROTEZIONE / SOMBRERETE
		203	960204 26200			KÜHLER / COOLER / REFRROIDISSEUR / RAFFREDDATORE / REFRIGERADOR
		204	969438 00000			L-VERSCHRÄUBUNG / L-PIECE / L-PIECE / PEZZO A L / ATORNILLADURA
		205	935200 10000			VERLÄNGERUNG / ADAPTOR / RACCORD INTERMÉDIAIRE / RACCORDO INTERMEDIO / ADAPTADOR
		206	969401 00009			SCHLAUCH / FLEXIBLE HOSE / TUYAUTERIE FLEXIBLE / TUBAZIONE FLESSIBILE / TUBERÍA FLEXIBLE
208	018303 26400			HAUBE / PROTECTING HOOD / CARTER PROTECTEUR / CARTER DI PROTEZIONE / SOMBRERETE		

²⁾ variantenabhängige Bauteile / variant-dependent components / composants variante-dependantes / componenti variante-dispendenti / componentes variante-dependientes

U 4.165	Variante 	Pos. ²⁾	Bestell Nr. / Ident No. / No. Identification / No. Identificazione / No. De pedido		Beschreibung / Description / Designation / Designazione / Desripcion	
			  	  		
⑥ U 4.165 SA/K-51 ⑦ U 4.165 F/K-51 - mit Ölbadheizung, Niveau-Geber und Thermostat - with oil bath heating, level transmitter and heat valve - avec chauffage du bain d'huile, capteur de niveau et thermostat - con riscaldamento a bagno d'olio, indicatore di livello e termostato - con calefacción de baño de aceite, codificador de nivel y termostato		61		002406 26400	ÖLABSCHEIDERGEHÄUSE / HOUSING FOR OIL SEPARATION / CARCASSE POUR SEPARATION D'HUILLE / CARCASSA SEPARATORE OLIO / CARCASA SEPARADORA DE ACEITE	
		62		951221 00100	VERSCHLUSSSCHRAUBE / LOCKING SCREW / BOUCHON / VITE DI CHIUSURA / TORNILLO DE CIERRE	
		282	741103 99682			NIVEAUGEBER / LEVEL TRANSMITTER / CAPTEUR DE NIVEAU / INDICATORE DI LIVELLO / CODIFICADOR DE NIVEL
		283	948086 00000			DICHTRING / SEALING RING / JOINT / ANELLO / ANILLO
		340	002408 26400			ÖLABSCHEIDERGEHÄUSE / HOUSING FOR OIL SEPARATION / CARCASSE POUR SEPARATION D'HUILLE / CARCASSA SEPARATORE OLIO / CARCASA SEPARADORA DE ACEITE
		341	960202 26400			ROHRHEIZKÖRPER / PIPE HEATER / CORPS DE CHAUFFE / SCALDIGLIA / CALEFACTOR TUBULAR
		342	943400 70000			TEMPERATUR-WÄCHTER / THERMOSTAT / THERMOSTAT / INTERRUPTORE TERMICO / TERMOSTATO
		343	948070 00000			KUPFERRING / SEALING RING / JOINT / ANELLO / ANILLO DE COBRE
		344	913116 00100			O-RING / O-RING SEAL / JOINT TORIQUE / GIUNTO CILINDRICO DI TENUTA / JUNTA TOROIDAL
		345	948011 00000			DICHTRING / SEALING RING / JOINT / ANELLO / ANILLO
⑧ U 4.165 SA/K-54 - mit zusätzlicher Ölablassbohrung - with additional oil draining bore hole - avec trou de vidange d'huile - con foro di scarico dell'olio aggiuntivo - con perforación de salida de aceite adicional		61		002406 26400	ÖLABSCHEIDERGEHÄUSE / HOUSING FOR OIL SEPARATION / CARCASSE POUR SEPARATION D'HUILLE / CARCASSA SEPARATORE OLIO / CARCASA SEPARADORA DE ACEITE	
		361	002407 26400			ÖLABSCHEIDERGEHÄUSE / HOUSING FOR OIL SEPARATION / CARCASSE POUR SEPARATION D'HUILLE / CARCASSA SEPARATORE OLIO / CARCASA SEPARADORA DE ACEITE
		363	951220 00100			VERSCHLUSSSCHRAUBE / LOCKING SCREW / BOUCHON / VITE DI CHIUSURA / TORNILLO DE CIERRE

²⁾ variantenabhängige Bauteile / variant-dependent components / composants variante-dependantes / componenti variante-dispendenti / componentes variante-dependientes